

A close-up photograph of a young child with dark hair, wearing a black long-sleeved shirt, focused on playing with modular blocks. The child is holding a white square block with a circular hole in the center, which is being placed onto a yellow cylindrical peg that is already inserted into a larger white square block. The larger block has two circular holes on its front face. The background is blurred, showing more of the child's clothing and the floor.

inspiration

MODU®



MODU®

**imagine, build,
move, imagine,
build, move,
imagine, build,
move, imagine**

...

Congratulations on your new MODU toy! You are now part of the #modiverse where imagination, creativity and active play rule. Use this booklet for inspiration when you go on fun play adventures indoors. Explore MODU's many functions with the general principles presented here and go even further by building your very own creations — imagine, build, move in an endless play loop!

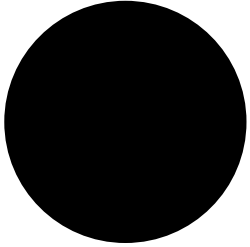

MODU ApS ©2019
Scandinavian Design

www.modu.dk



6 – 31

32 – 39

40 – 45

creation ideas

nice to know

behind the scenes



creation ideas



rocker

ages 1 - 3



it may look like you're getting
nowhere, but in your mind you
can go anywhere!

.....

A rocker exercises both the balance and front/back muscle control of the body. It's especially good for small children because of the senses that it promotes. Rocking movements stimulate the vestibular (inner ear) system, which can encourage your growing sense of balance.



use long pegs
as handles when
building ride-on
creations

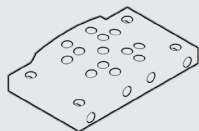
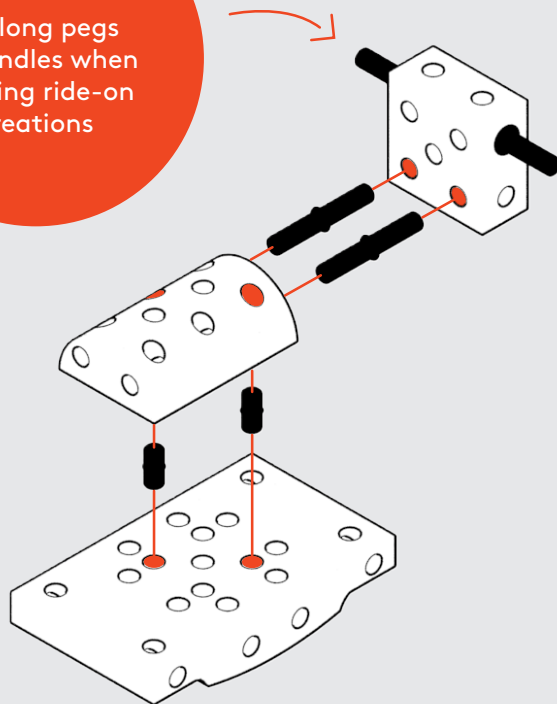

x1

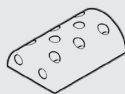

x1

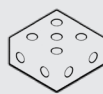

x1



x4



x2

tilter

ages 3 - 6



jump on board and imagine
yourself surfing the big waves
of the Hawaiian shore

.....

Exploring your balance is both helpful and challenging no matter how old you are. On a tilter you enhance balance, spatial awareness, weight transfer and coordination either standing, sitting or lying down. Challenge yourself or a buddy and flip it upside down for an easier start.

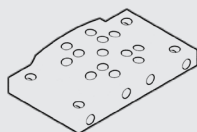
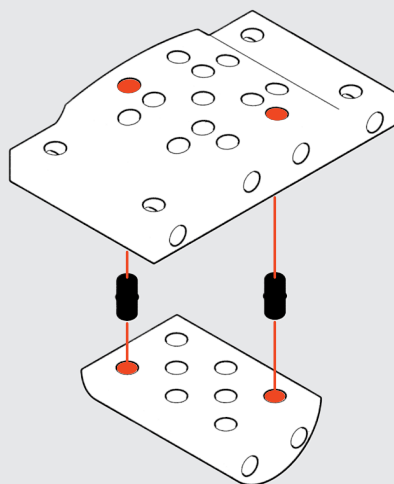

x1

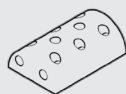

x1



x2

floor board

ages 0.5 - 4



it's fun how mom's face changes
perspective, when moving away
and then returning

.....

Lying on your stomach will exercise important neck and back muscles, including those which help you keep your head up high. From the belly position you will continue exercising your arms and use them to spin yourself around.



short pegs can
be used as handy
handles on your
floor board

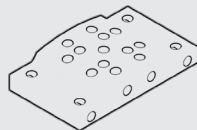
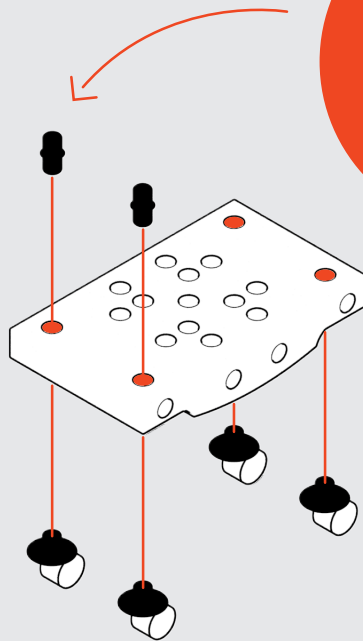

x1



x2



x4

swirly rider

ages 2 - 5



“Get your motor runnin’. Head out on the highway. Lookin’ for adventure”
.....

Exercise bilateral coordination by holding on and steering while using your legs to speed up. A swirly rider can spin, ride forward and backwards and change direction — all these movements strengthen your core and exercise your ability to hold an upright position.

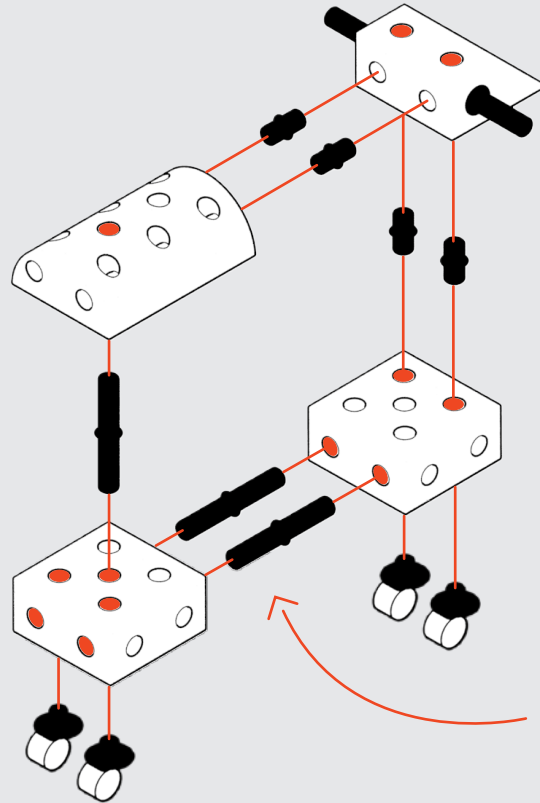

use two long pegs
when creating seats
for your rides to
increase stability

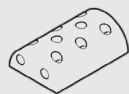

x1

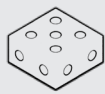

x2

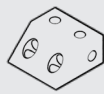

x1



x5



x4



x4

stand-up'er

ages 8 - 15 m



getting up by yourself for the
first time feels like reaching
your first summit

.....

Standing up is the first step to taking your first step — and getting up on your feet is hard! It requires something stable to hold on to. The handles give you something to grab onto when moving from a sitting position to a standing position.

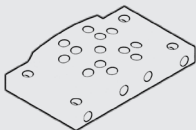
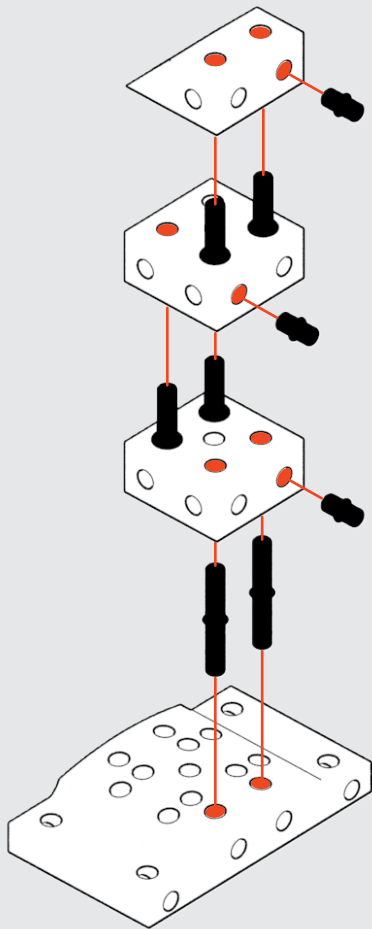

x1

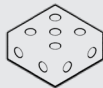

x2

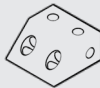

x1



x6



x3

obstacle course

ages 2 - 5



the floor might be made of
lava but the stones are safe
and foamy

.....

Obstacle courses are both fun balancing and great for training jumps! As you move from one block to another, the ability to release ground and prolong the jump phase is exercised — and you also stimulate your depth perception! The longer the 'stones' are apart, the greater the challenge.



use blocks as 'stepping stones' and flip some over to increase the challenge

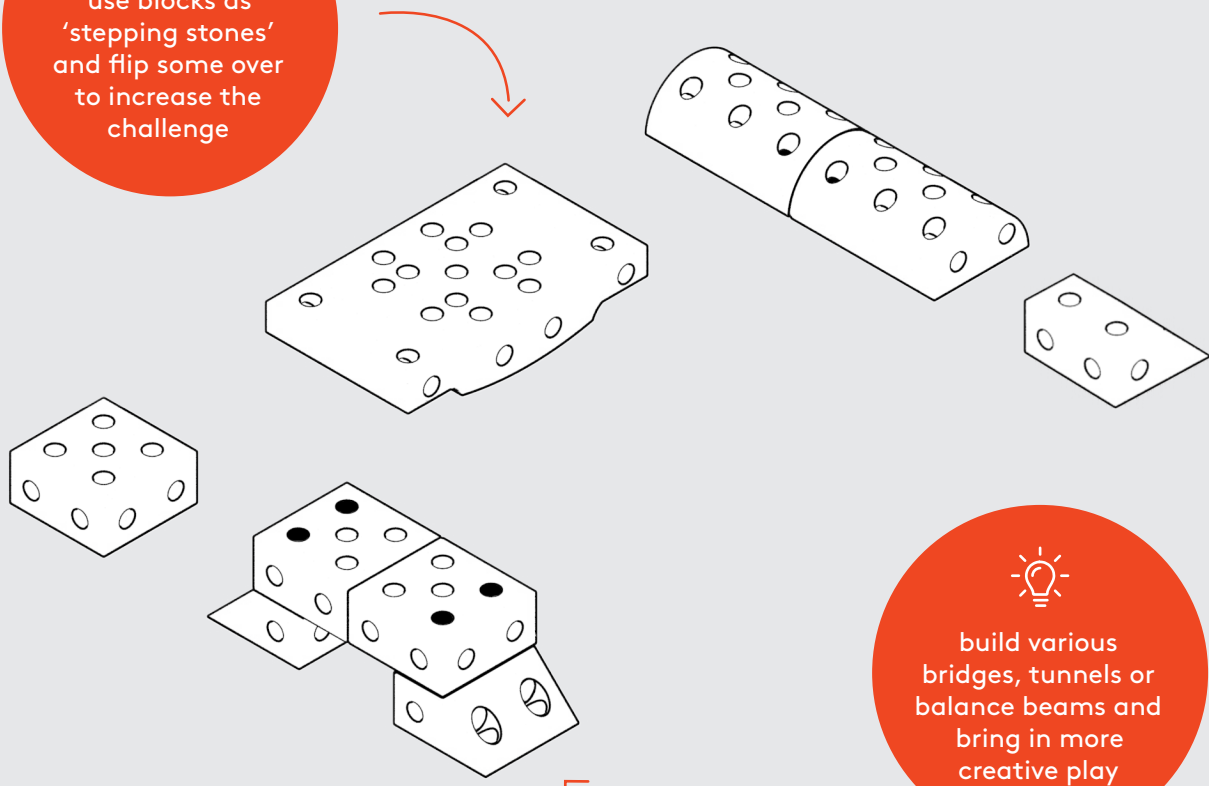

build various bridges, tunnels or balance beams and bring in more creative play

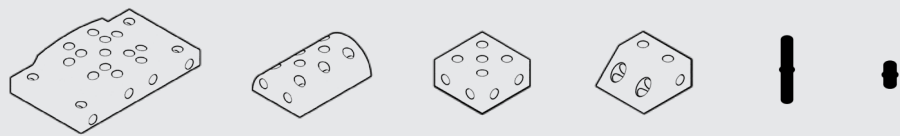

walker

ages 0.8 - 2



bring along your favourite toy
or a buddy on the wagon and
travel together

.....

Practice walking with a push-wagon and experience how your world opens up. Feel the freedom and fun of exploring. Learning to walk is largely a matter of trial and error. So just keep at it, and be patient 'cruising' around.

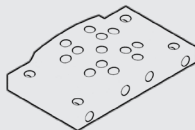
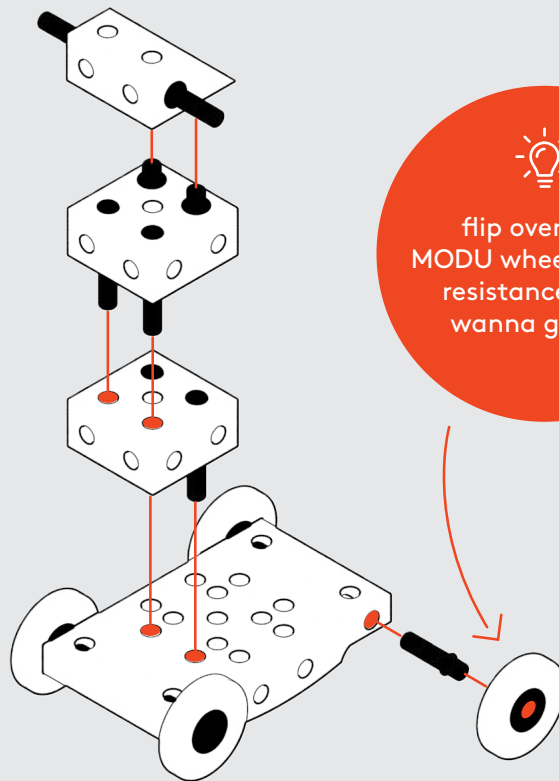

x1

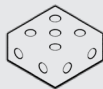

x2

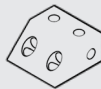

x1



x6



x2



x4



x4

roller

ages 2 - 6



put your balance to the test
either standing, sitting or on
your belly

.....

Training static balance with small movements requires good sense integration between the vestibular and proprioceptive sensory system. It is always a good idea to have a buddy hold your hand at first. For older kids, balancing makes for a great contest — who can stay on the longest?

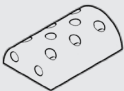
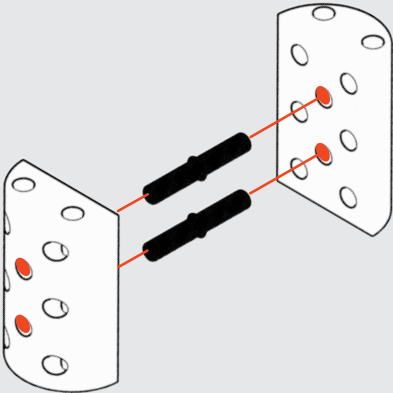

x 2



x 2

straight rider

ages 1 - 3



one ride might look like the other, but to the owner it feels improved with any alteration

.....

A straight rider is more stable than a swirly rider. That's why this type of rider is great for younger kids. It can move fast or slow depending on how you attach the wheels. It also strengthens bilateral coordination and lets you sense speed and rapid shifts in forward/backward direction.

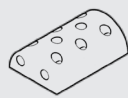
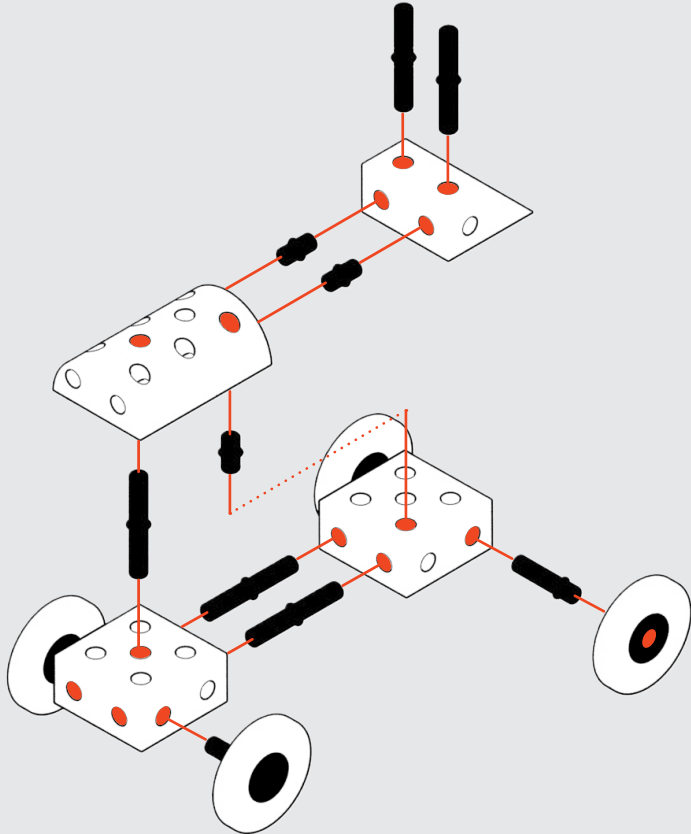

x1

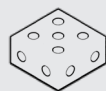

x2

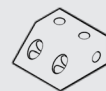

x1



x5



x3



x4



x4

racer

ages 2 - 6

the world's coolest formula
one car with 100% CO₂-neutral
propulsion

.....



Being pushed on a cart and feeling out of control is exciting for both buddies or siblings. Pushing a cart is hard work and will stimulate the proprioceptive system, i.e. the sense of the relative position of your body parts and strength of effort being employed in movement.

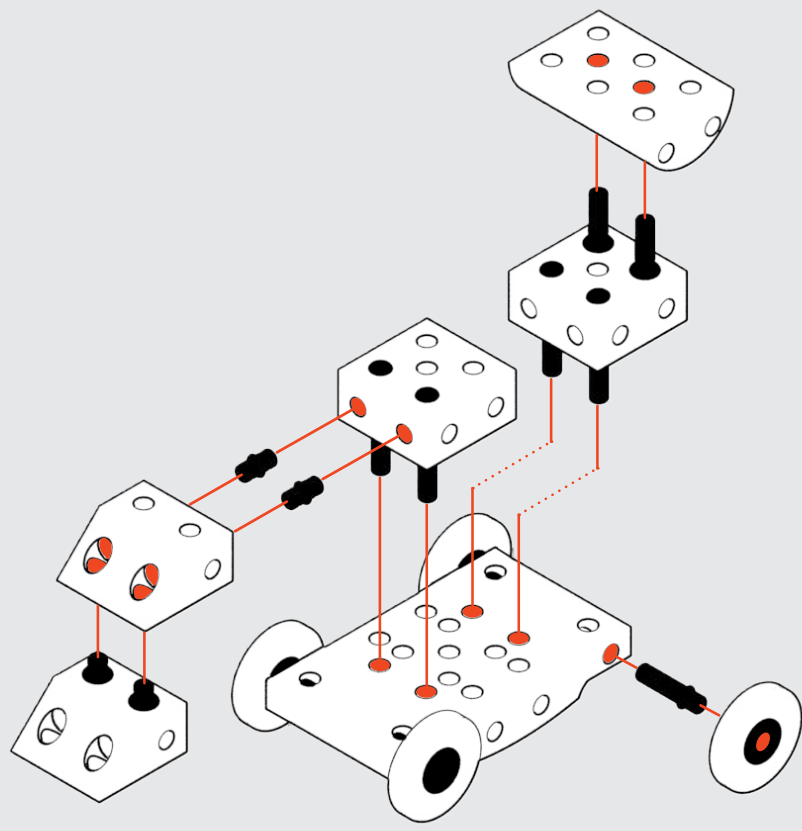

- x1
- x1
- x2
- x2
- x6
- x4
- x4
- x4

climber

ages 2 - 6



build mountains to be
conquered and get inspired
during your epic climb

.....

Putting blocks together is explorative and you never know where you'll end up — that's the whole point of open-ended, creative play. In addition to being physically demanding for the body, climbing your creations also develops motor skills, balance and motion coordination.



build different
climbing creations
depending on your
selection of
blocks

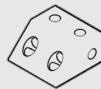
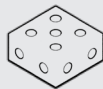
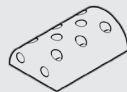
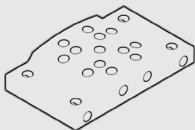
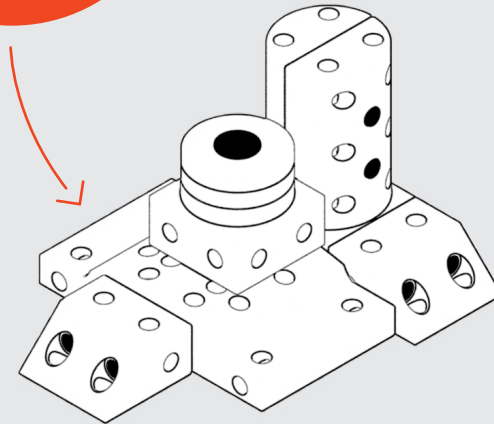

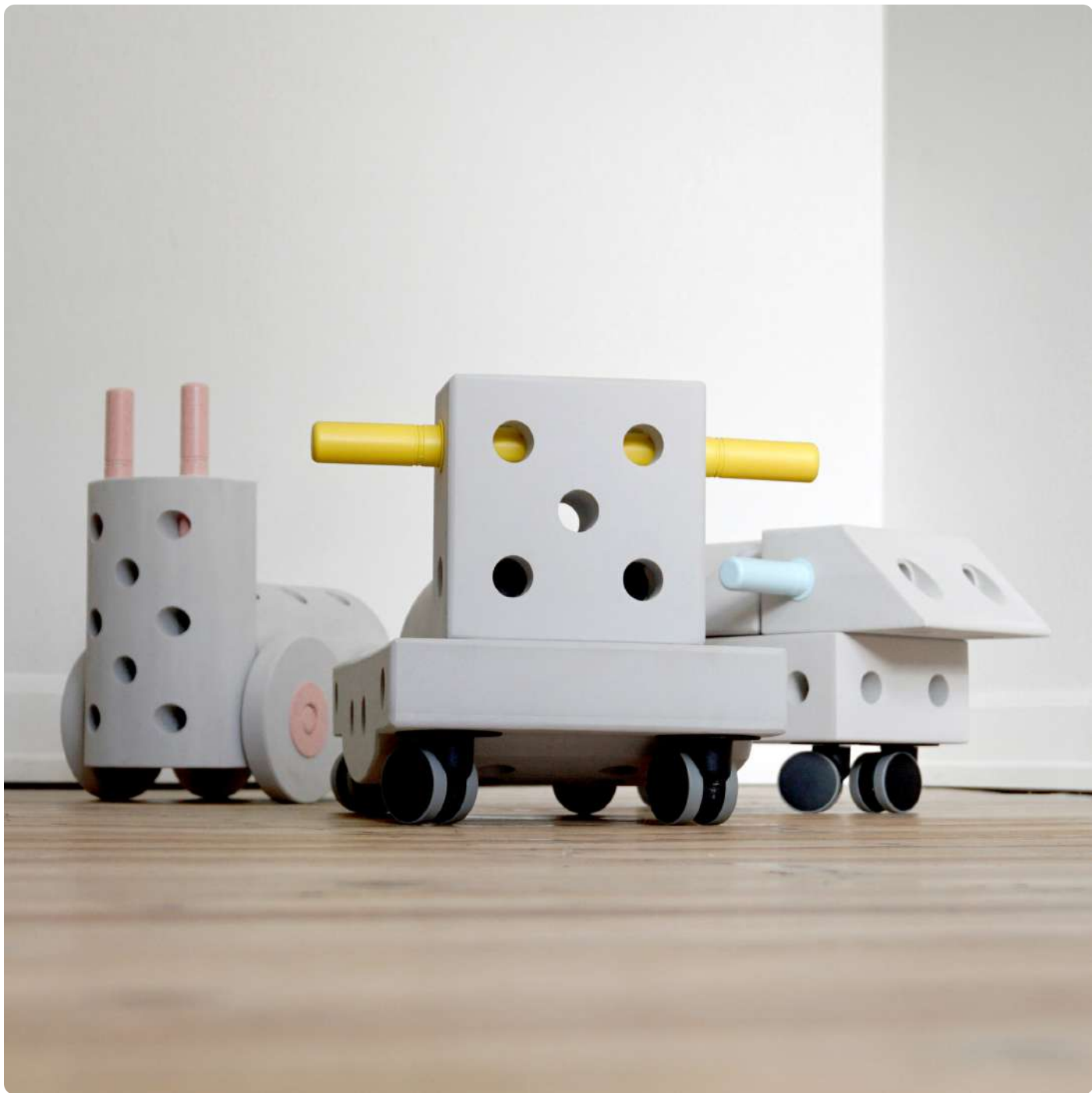

By now you've probably unlocked so many great play experiences already. You might want more MODU elements to build bigger or more creations. Or what about an extra pair of wheels for a race among buddies? Look out for new possibilities in the future...

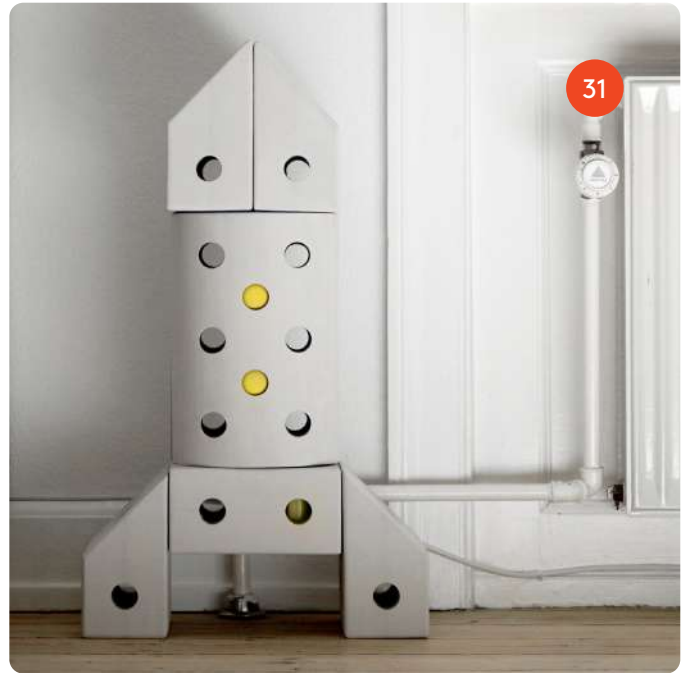

learn more at www.modu.dk

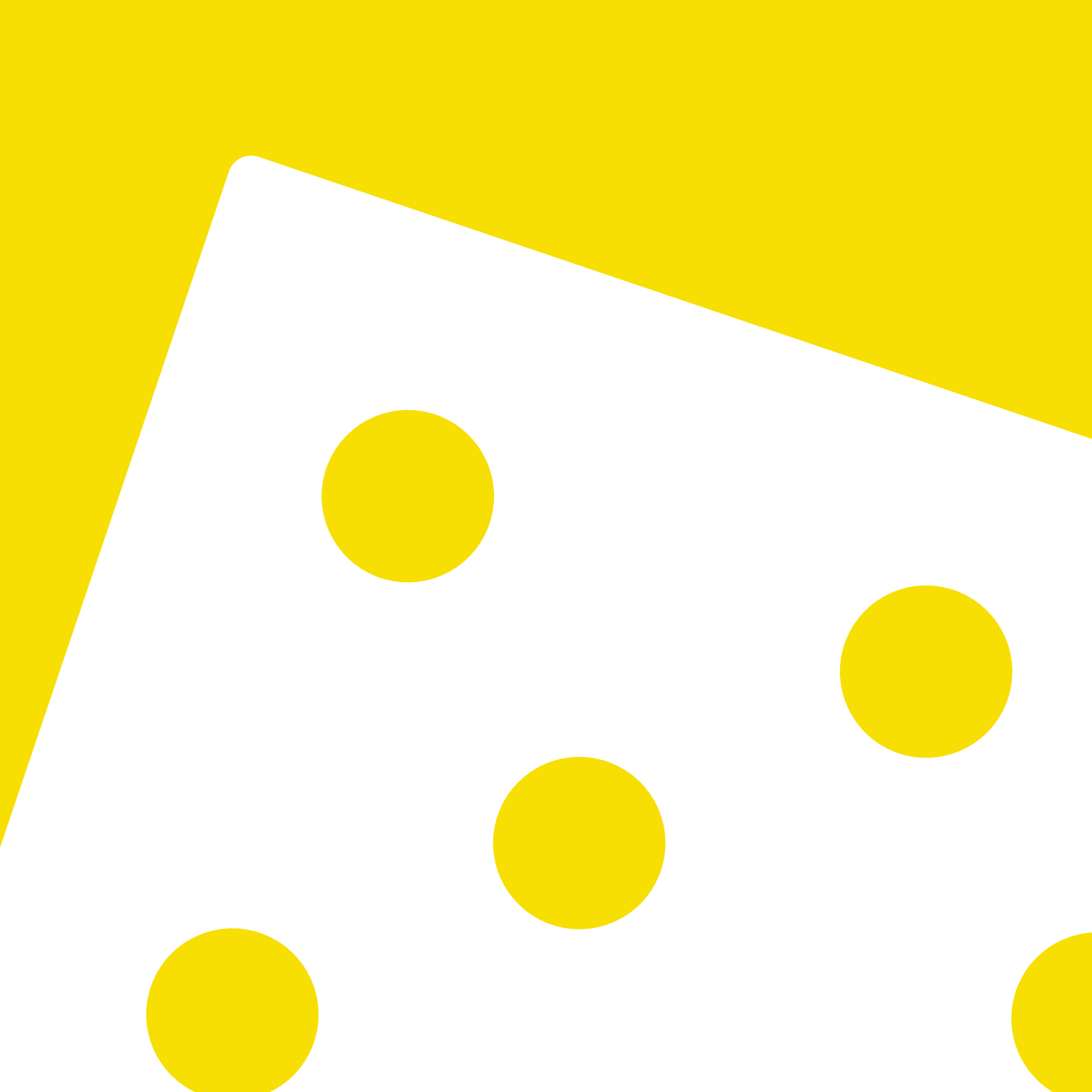

nice to know

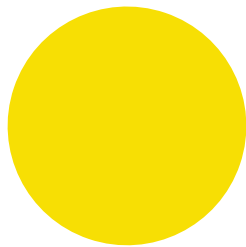



elements

35



BLOCKS; are not just building blocks. Use them as stepping stones or discover each of their unique characteristics — some are stable while other will wobble, tip and rock.

PEGS; can be used as both connectors, handles and foot bars — and even tails or ears on a monster. That's also why there are different lengths. Long pegs are often good for building stable creations.

WHEELS; can make your creation run in all directions. The small wheels are fast for swirling fun. The big wheels can be combined with the pegs in two ways: One will run freely, while the other will have some resistance to it. The latter is useful during the early stages of walking and riding.





upkeep

From time to time your MODU blocks will become dusty, sticky, wet and sometimes sad...

Use some hot water or your dishwasher (max. 40 °C) for a refresher — or simply bring your MODU next time you bathe and give them a good scrub. 🦆

NB! Your blocks also get bored and lose a bit of life if they are left in the corner for too long. Play with MODU and they will remain fresh and happy at all times.





storage — if strictly necessary!

If for some reason you absolutely, positively have to store away your MODU kit, feel free to build something fancy for your room, which features all your MODU elements. This could be a small table and stool, or perhaps even a cool sculpture?

When all else fails, MODU can be flat-packed and stored under the couch or behind a door.

Let MODU be part of your living room and everyday life. Your blocks are most happy when they are being played with — all the time!







behind the scenes



we dream of a future
where kids develop and
are enabled to inspire
us through more open-
ended, active play.



We're a Copenhagen-based team of designers, dreamers and doers united by one goal: to help kids make active and open-ended play the naturally preferred choice.

We believe that MODU solves an important and very real problem; screens are taking over children's lives, and this sucks because activity and motor skill stimulation form the foundation of both physical, linguistic and social learning. We've designed MODU to meet all the natural needs a child has

in active play. We do that through a fun, imaginative and long-lasting toy, which encourages and supports every stage of your child's development.

And the greatest thing: the tangible and interactive aspect of MODU is great for collaborative play in all ages, both among kids and adults. We call it a play loop and everyone can be part of it: imagine, build, move, imagine, build, move, imagine, build, move, imagine, build, move...

Being super age-adaptable, MODU is the epitome of sustainable toys — a toy with a long life cycle that stays fun & relevant for years. Or as we like to say: "A toy that helps you grow and grows with you."

We produce MODU through two carefully selected toy manufacturers in Denmark and in the Far East. Both partners live up to Danish standards and comply with our ethical values regarding human rights, labor laws, anti-corruption and the environment. We regularly visit our manufacturers and we use trusted agents to maintain continuous communication and uphold our high expectations for quality.

sustainable in every way

Our blocks consist of tough and tactile EVA-foam. Pegs and wheel hubs are made from food-grade ABS. All parts are 100% phthalate- and BPA-free, and approved for kids' toys through the European Standard for Toys.

Our materials are fully recyclable and we employ you to sort your MODU elements once you're done with them. When technology catches up, we aim to switch to bio-based materials.





what are you creating? get inspired & share your greatest play moments & creations online using **#moduverse**

The fine print: — This inspirational booklet contains various examples of creations. Some cannot be built with the smaller starter kits available. — All rides created using the small wheels (e.g. 'swirly rider') are not meant to be completely stable and therefore should be treated as balancing toys to be played with under the supervision of an adult. — To ensure stability of certain rides, we encourage the building process to be supervised by an adult. — We discourage any unsupervised play with the pegs for kids under the age of 8 months, or kids who cannot sit upright on their own. — When using the dishwasher for your blocks, be aware of pointy tray ribs that can leave marks and use a short program on 40° Celsius or lower. — We take safety seriously and we use independent consumer labs to ensure that all our parts are safe and certified: MODU is CE certified and compliant with the European Standard for Toys covered by EN 71. — All our blocks are handmade, and may vary somewhat in size and shape. For any enquiries please write us at hi@modutoy.com



MODU ApS ©2019
Scandinavian Design

www.modu.dk

